

ASSEMBLY INSTRUCTIONS:

Product Code : CDK96 / CDK126 / CDK1575 / CDK189 /
CDK1875 (Worker Range only)

Product Name: Rapid Vibe & Worker Corner Desks

TIME REQUIRED:

20 minutes

TOOLS REQUIRED:

Screwdriver, Electric Drill, Pencil, Measuring tape/Ruler

*Tools are not included.

SKILL REQUIRED:

Easy ●●●○○ Hard

The Assembly Skill Rating is a 5-point system that shows the degree of effort needed in assembling a specific product. With 1 being easy for the average person and 5 requiring an expert. For most products, two persons are recommended.

Please note, as this is a commercial product, some intermediate skills are required.

*No pre-drill holes or markings are provided on tops.

NOTE

- As this is a commercial product, some intermediate skills may be required.
 - No pre-drill holes or markings are provided on our table or desk tops.
 - Please check you have all hardware before assembling.
- If you are missing any hardware, please contact your Rapidline reseller. Please ensure you have the name of the item, required hardware part and quantity.
 - Please retain your receipt as proof of purchase to validate your warranty.
- Assemble on a clean, flat, smooth surface such as a rug or carpet to avoid parts from being scratched.
 - Remove all wrapping materials, including staples and packing straps before you start to assemble
 - Keep all hardware parts out of reach of children.

CAUTION

- Heavy product. Do not attempt to lift or move without help
- Do not tighten screws and bolts until completely assembled.
- Do not use this product unless all bolts and screws are firmly secured and tightened.

WARNING

- If parts are missing, broken, damaged or worn stop using the product until all repairs are made.
 - Failure to follow these warnings could result in serious injury.

ASSEMBLY INSTRUCTIONS

CDK1575

CDK1875(Worker Range only)

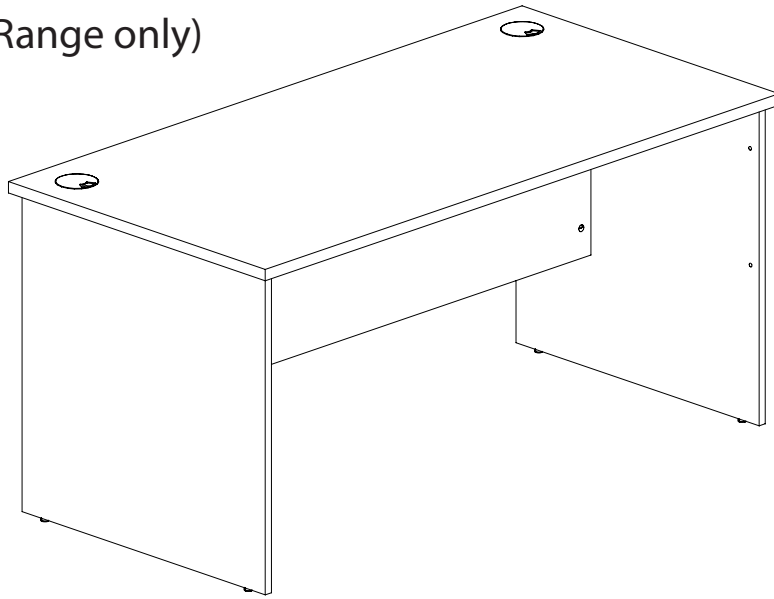

rapidline
FURNITURE FOR TODAY

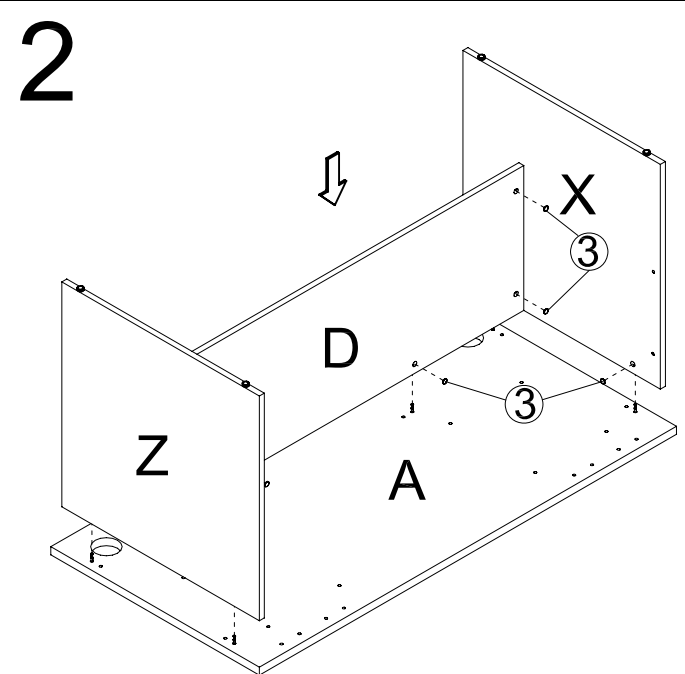
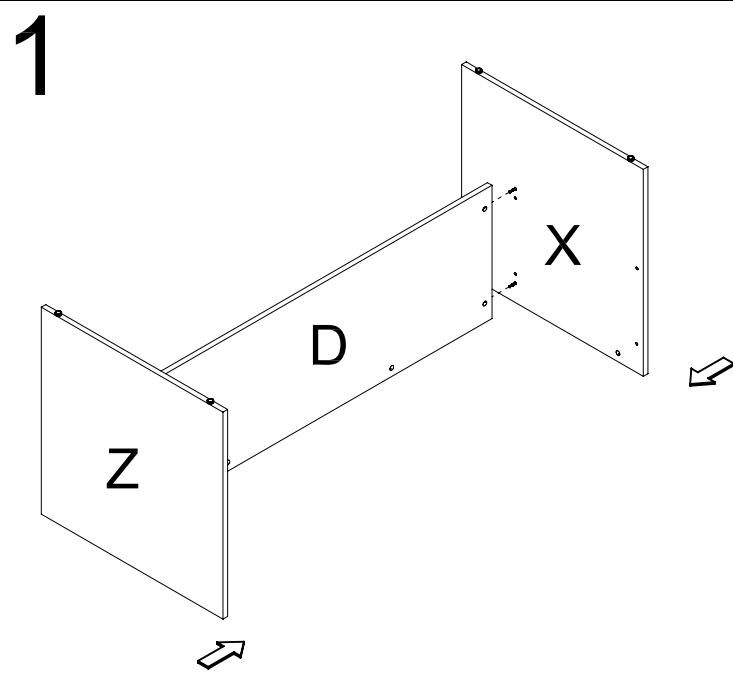
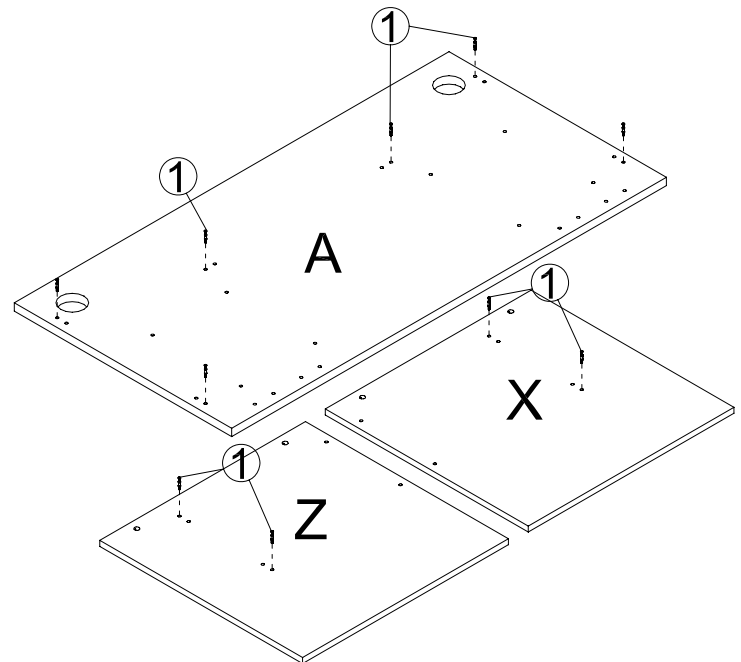
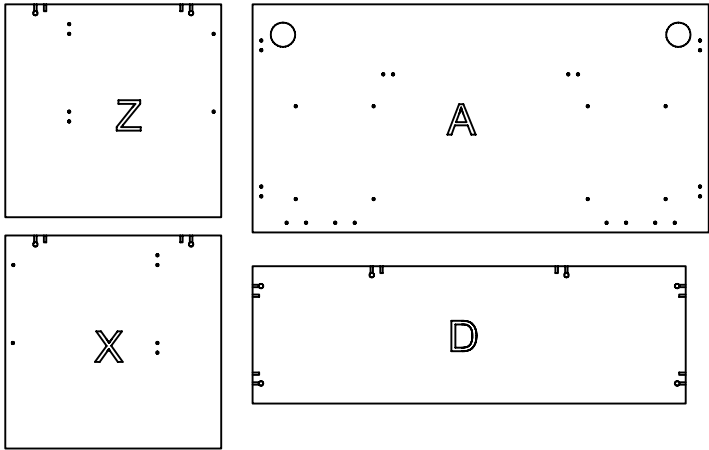
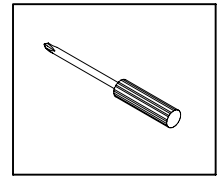
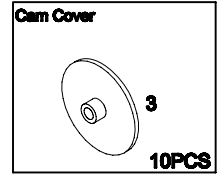
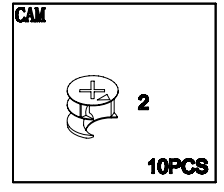
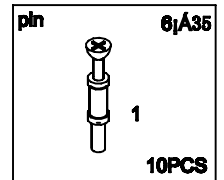



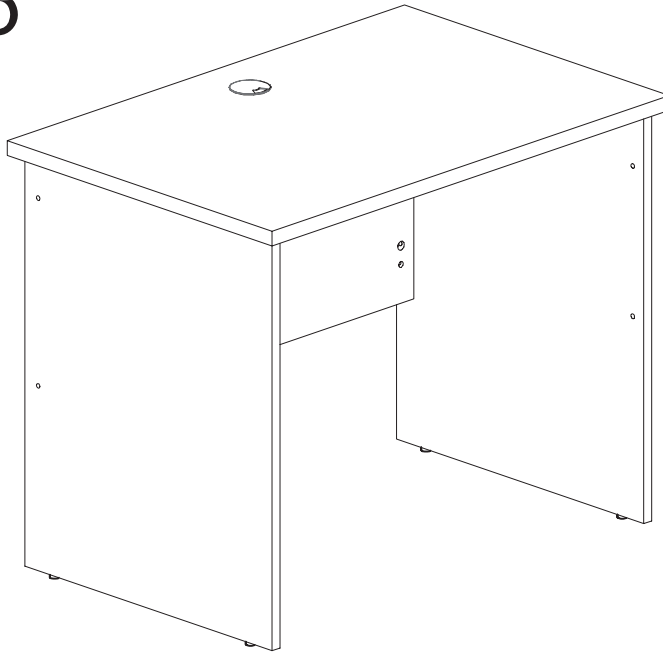

ASSEMBLY INSTRUCTIONS

CDK96

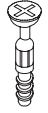
rapidline
FURNITURE FOR TODAY

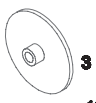

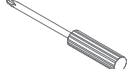
pin	6x35		1	10PCS
CAM			2	10PCS
Cam Cover			3	10PCS
CAM			4	4PCS
Screw	6x50		5	4PCS
				

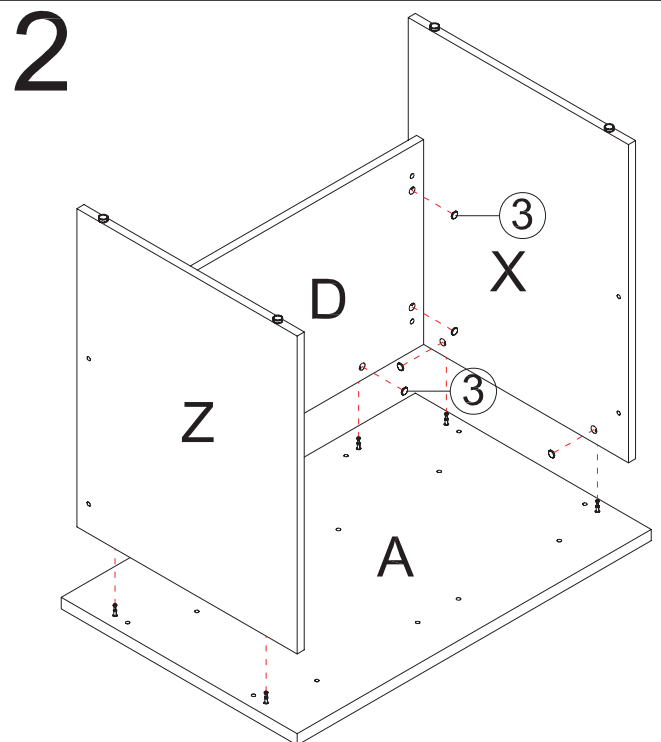
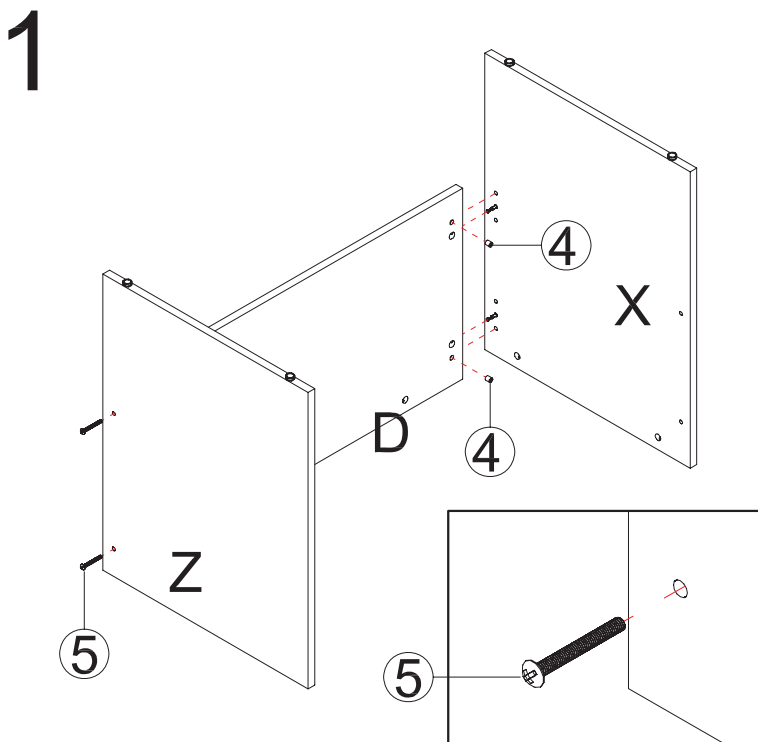
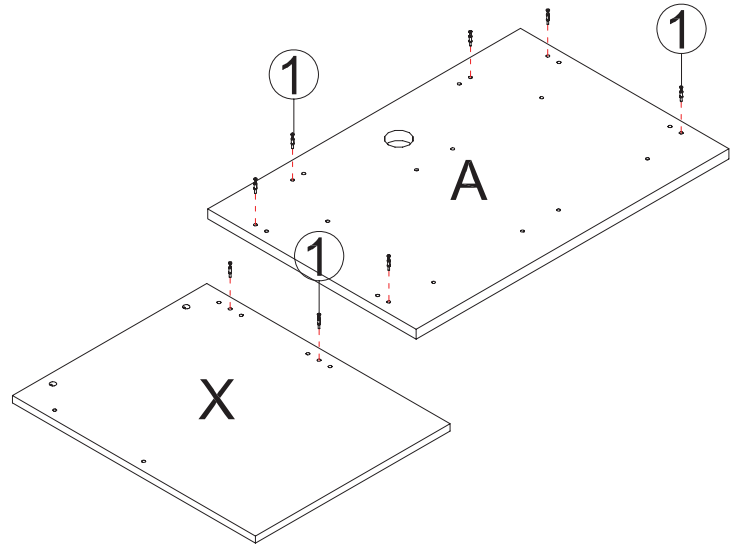
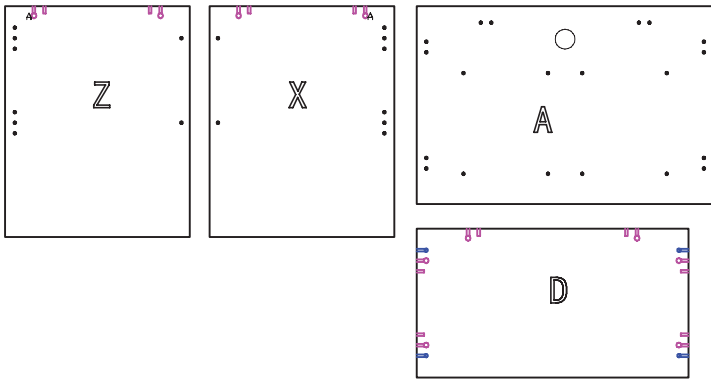



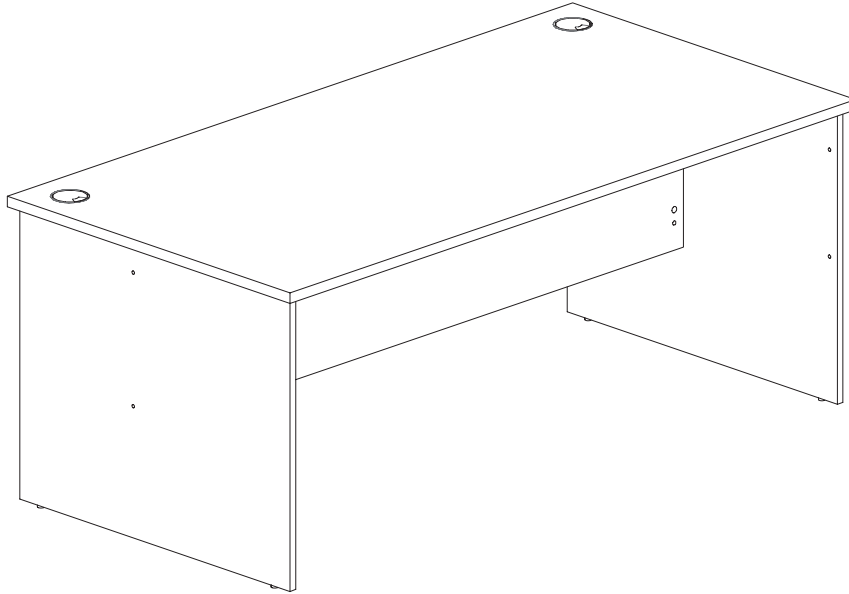

ASSEMBLY INSTRUCTIONS

CDK189

rapidline
FURNITURE FOR TODAY

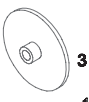

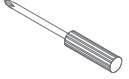
pin	6x35		1	10PCS
CAM			2	10PCS
Cam Cover			3	10PCS
CAM			4	4PCS
Screw	6x50		5	4PCS
				

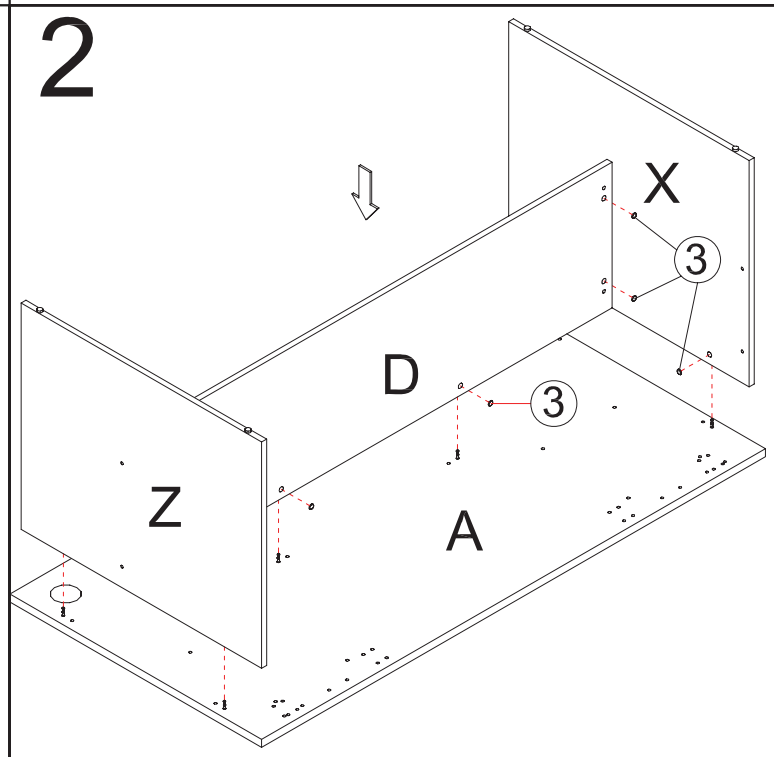
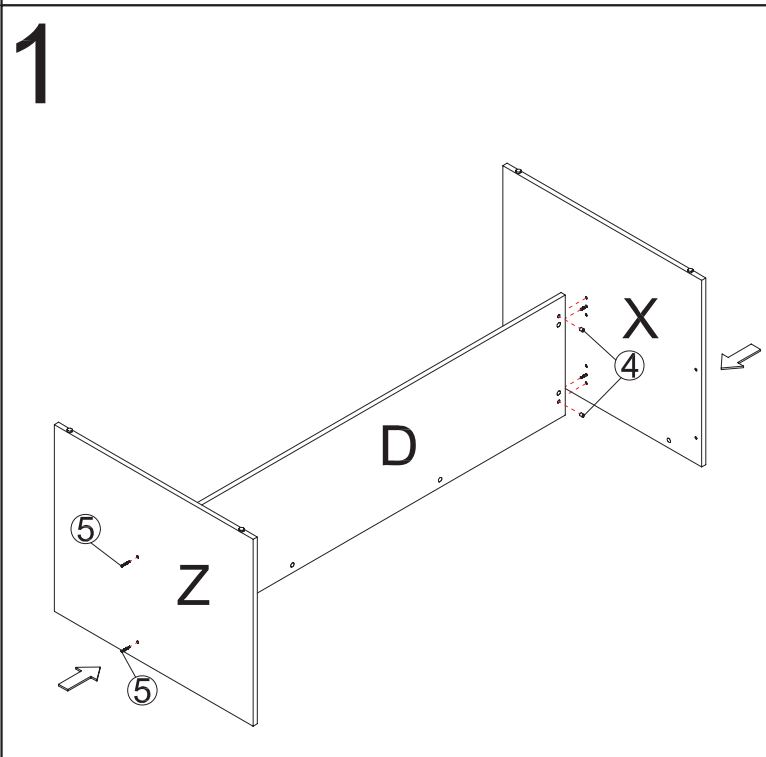
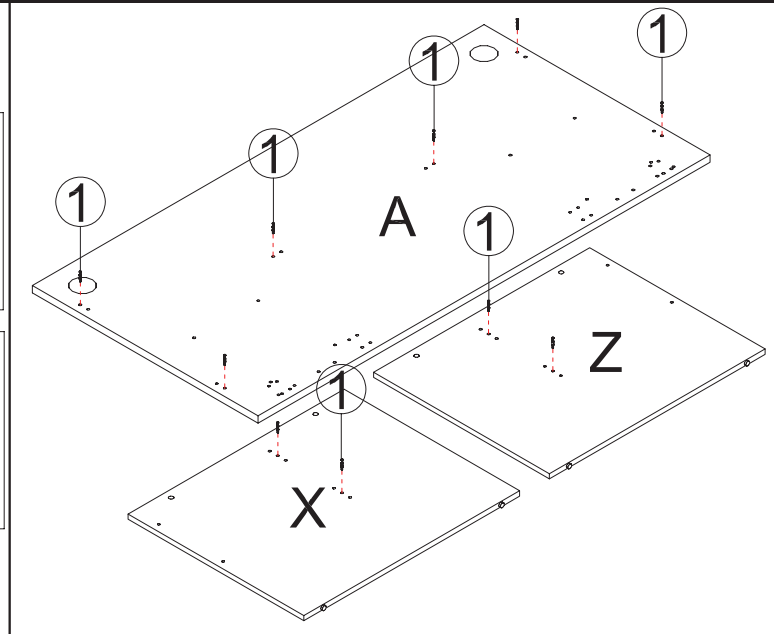
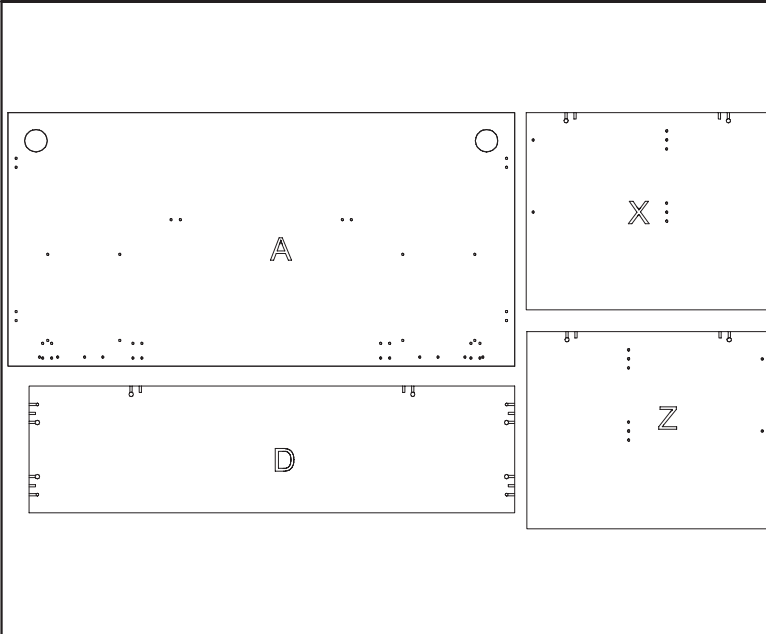



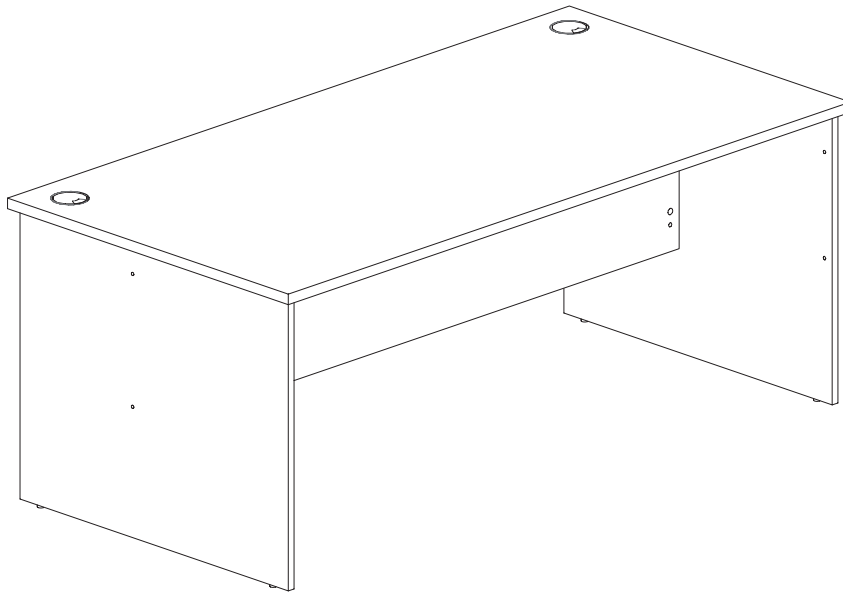

ASSEMBLY INSTRUCTIONS

CDK126

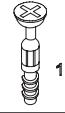
rapidline
FURNITURE FOR TODAY



pin	6x35		1	10PCS
CAM			2	10PCS
Cam Cover			3	10PCS
CAM			4	4PCS
Screw	6,1 A80		5	4PCS
